



SAHAJANAND LASER TECHNOLOGY LTD.

**PHOTONICS FOR DIVERSE APPLICATIONS
LEADING THE WAY TO INNOVATION**

Dr. Arvind Patel



GROUP TODAY

Industrial
Laser

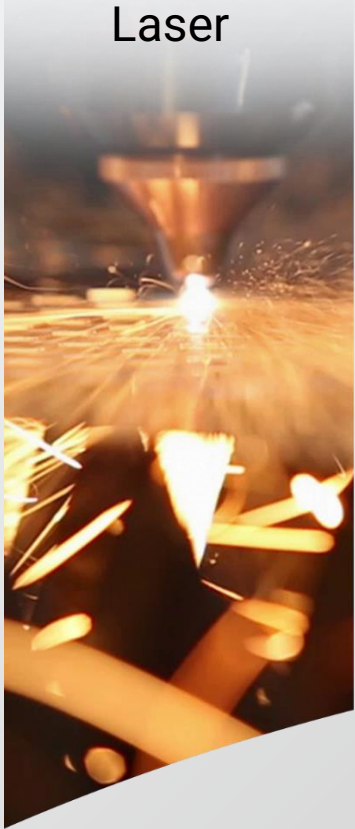

Diamond
Processing



Medical
Devices



Defence &
Space



Renewable
Energy



Hi-Tech
Software

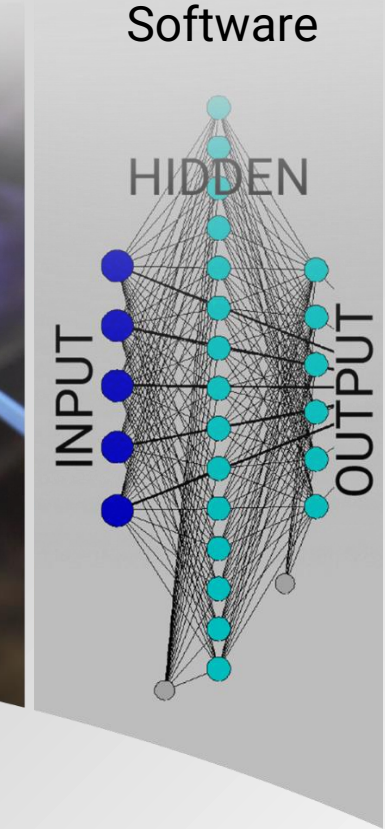

INDUSTRIAL SOLUTIONS

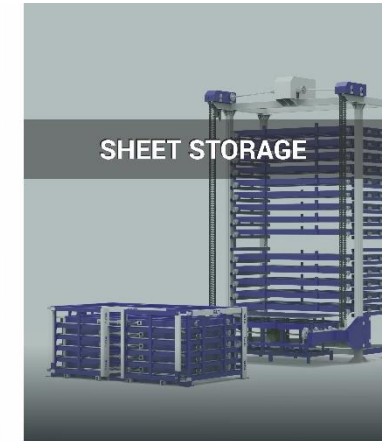
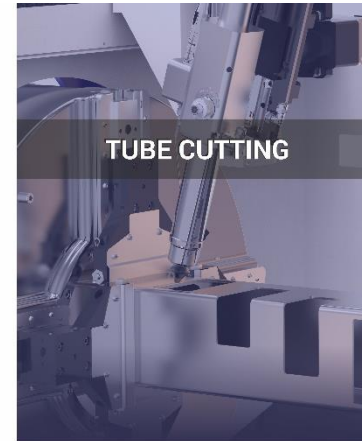
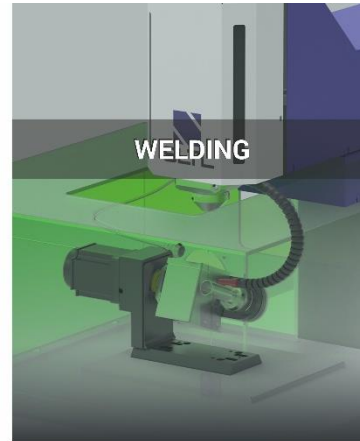
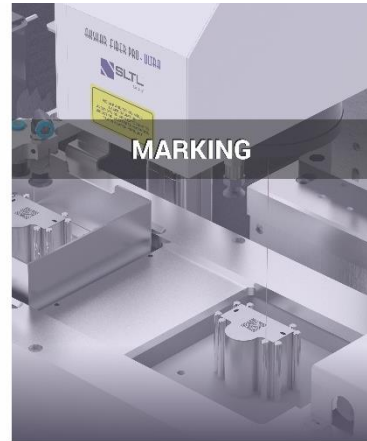

DIAMOND – ONE STOP SOLUTION

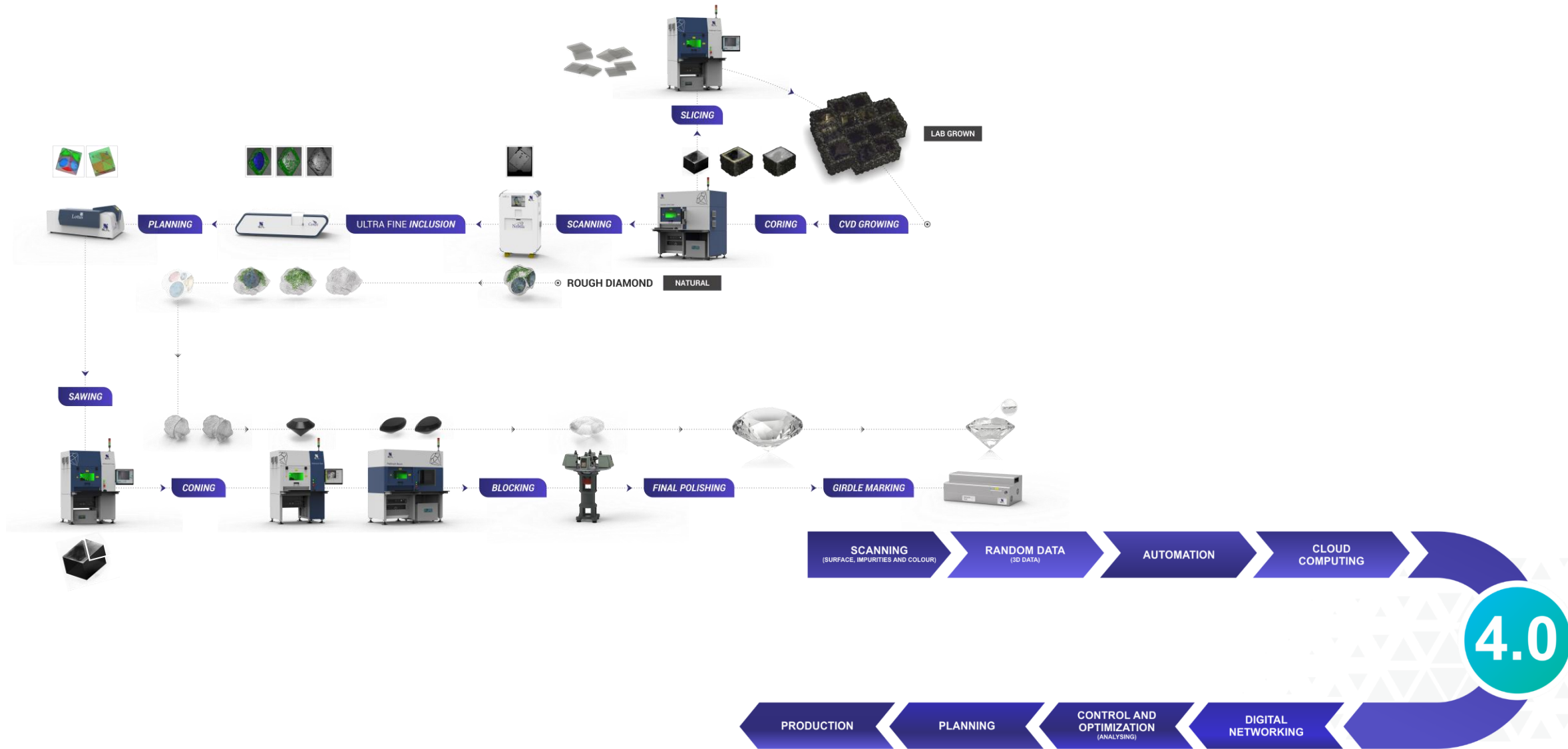

MEDICAL APPLICATIONS

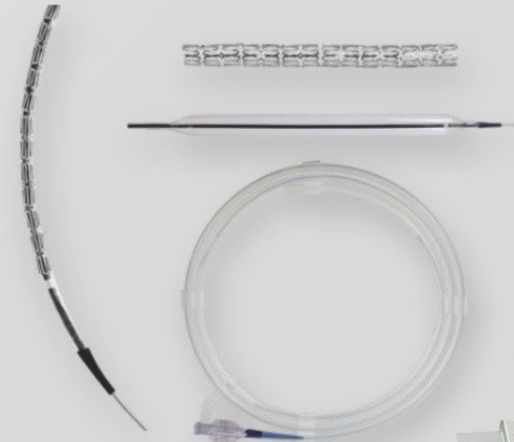
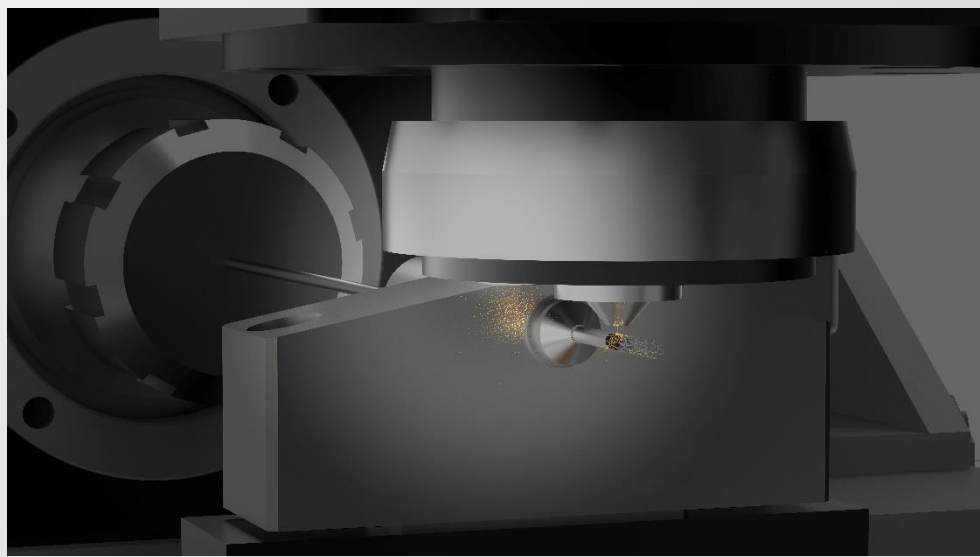

Balloon
Manufacturing



Stent Manufacturing

MEDICAL APPLICATIONS

STENT CUTTING

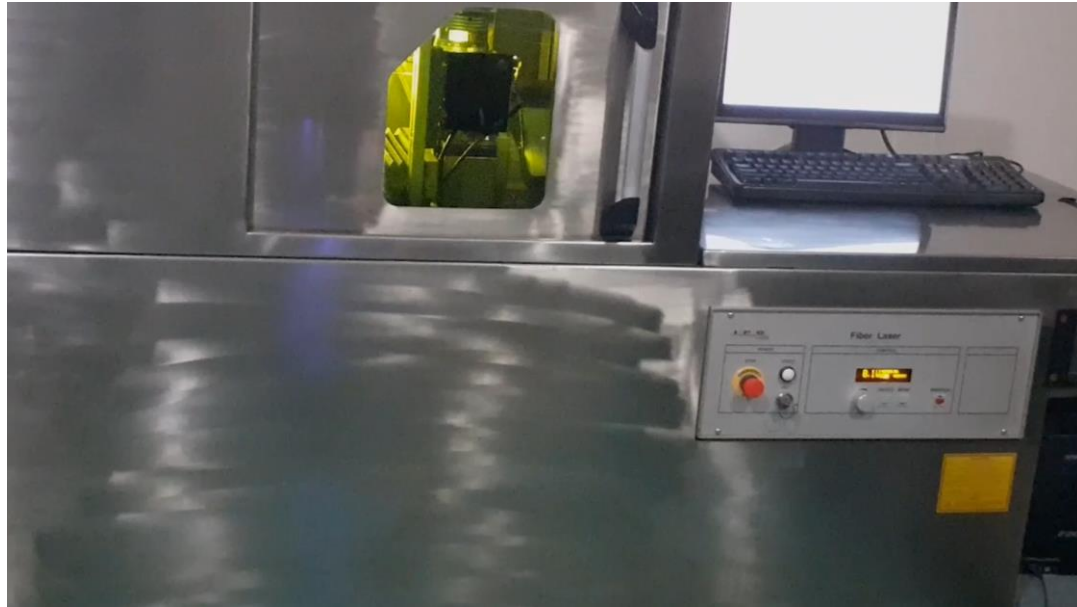

BALLOON WELDING

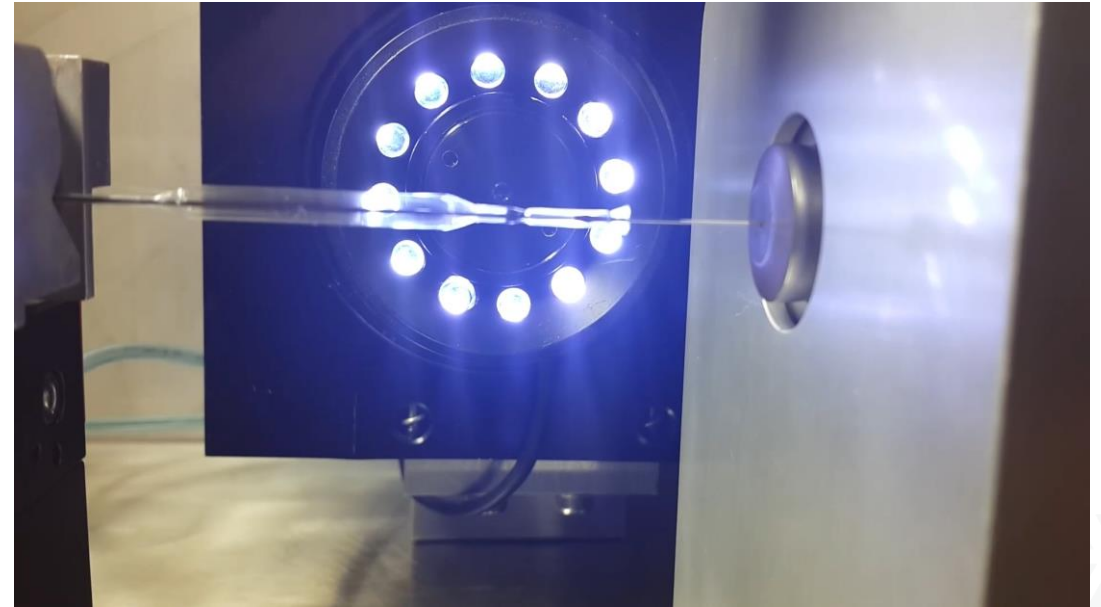

COMPOSITE CUTTING AUTOMATION

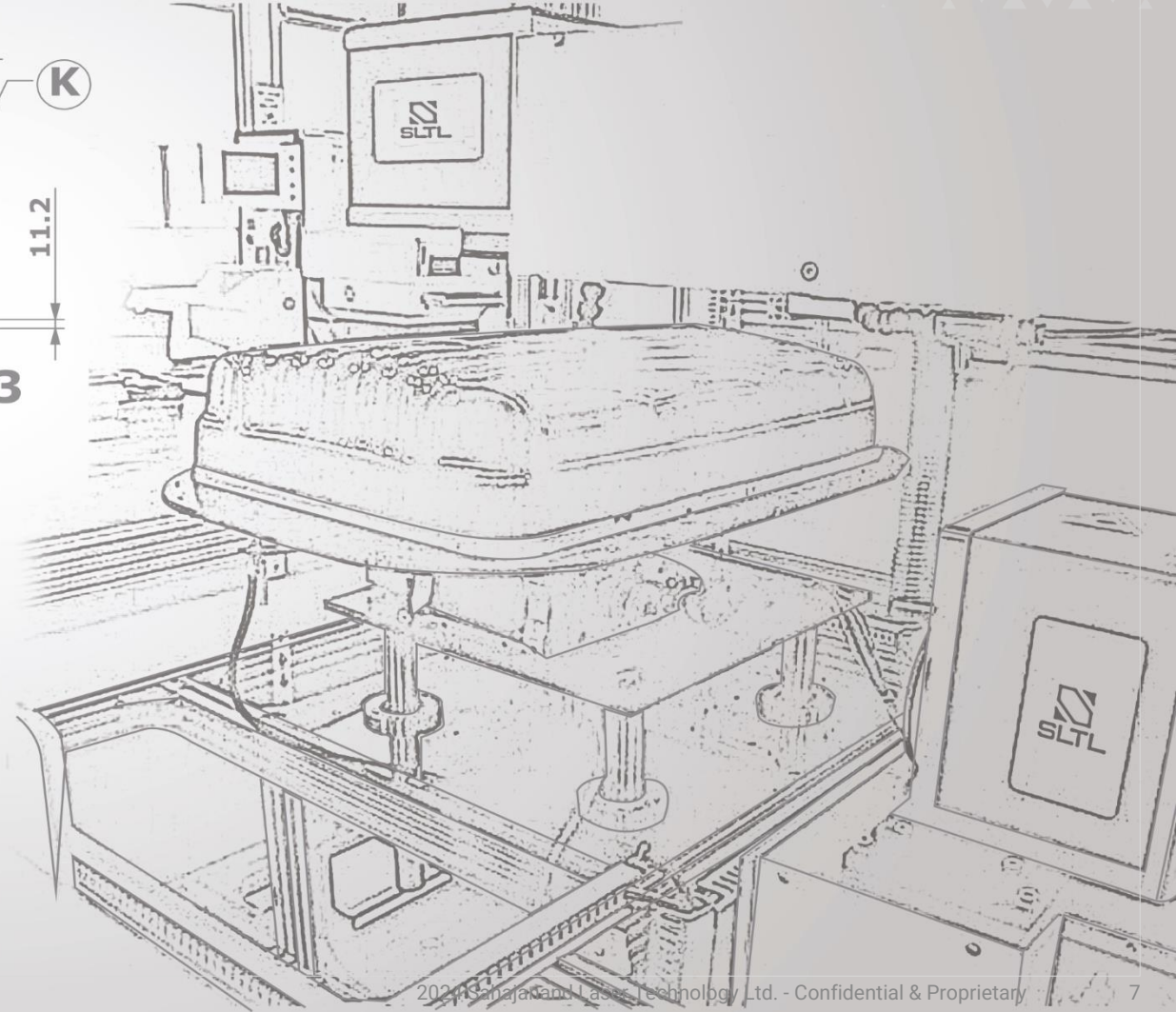

COMPOSITE CUTTING AUTOMATION



CVD GROWING

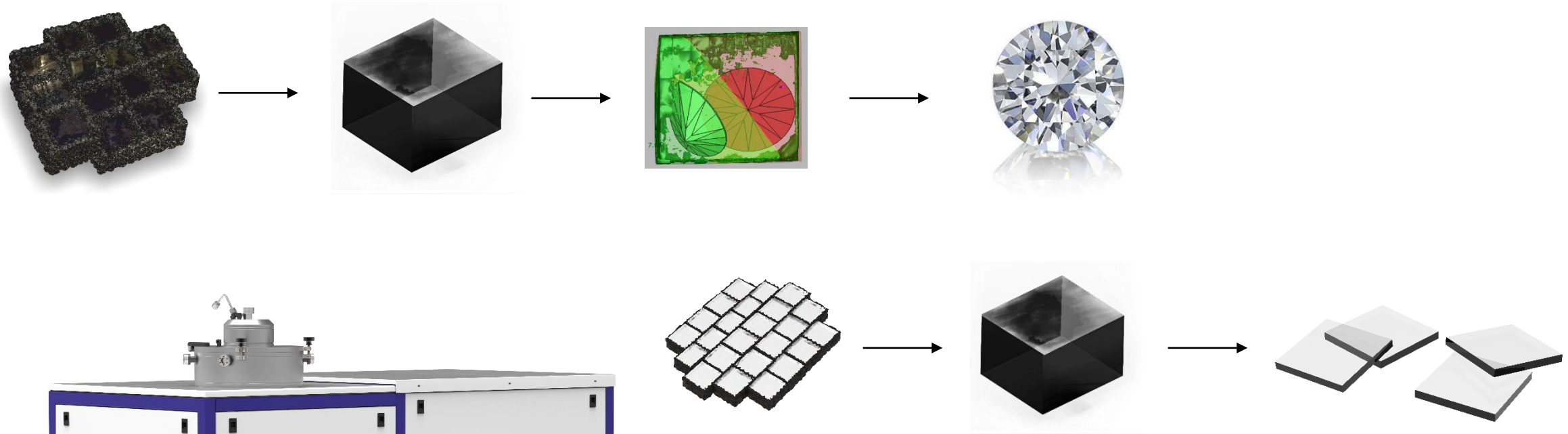

#LaserExperts | @SLTLGroup

X5 - FLEXIBLE LASER CUTTING SYSTEM

REDEFINING OPERATIONS

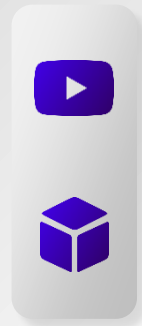
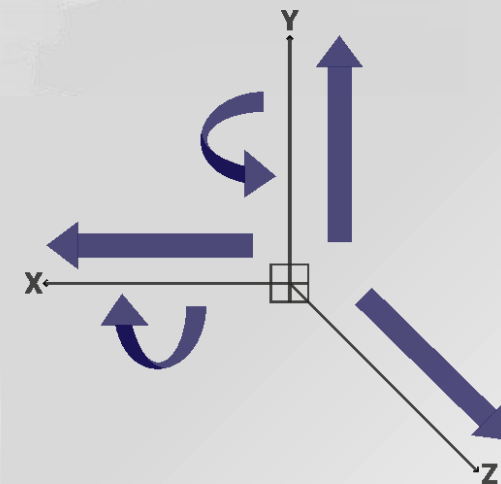
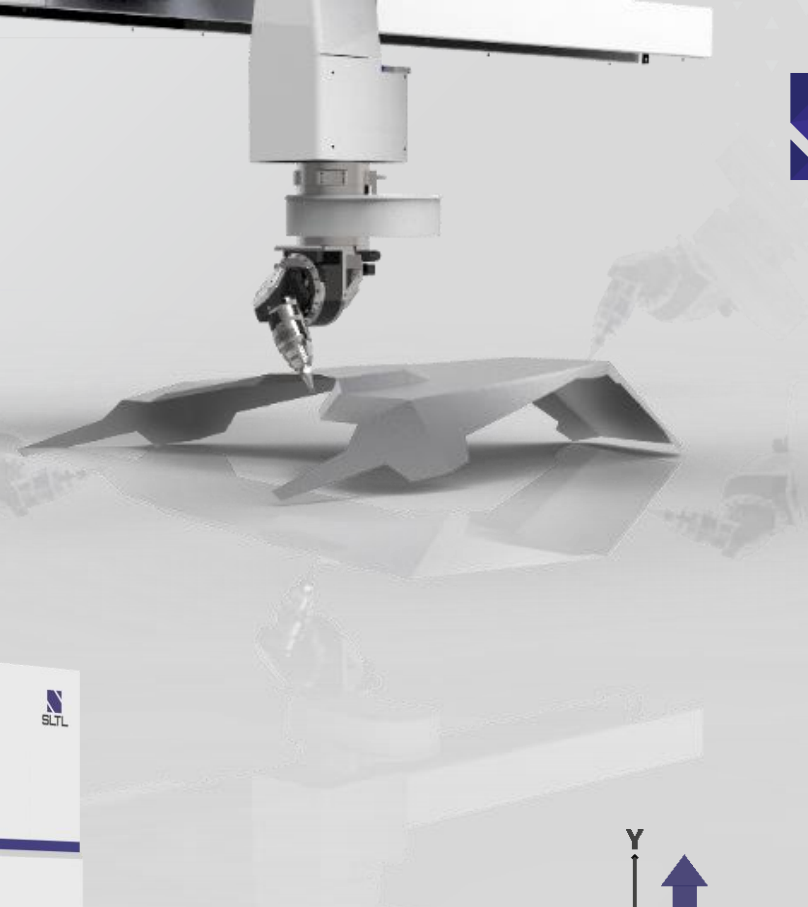



“
Dynamic beam 3D Laser cutting
& welding machine;
using Coherent
beam combining technology. ”

ON THE ROAD TO
VICTORY!

144kw

SLTL Group Developed



LASER MICROMACHINING & PRECISION SYSTEM

- ❖ Laser Micro Drilling
- ❖ Laser Micro Milling
- ❖ Laser Micro Cutting
- ❖ Laser Micro Patterning
- ❖ Laser Micro Scribing
- ❖ Laser Dicing

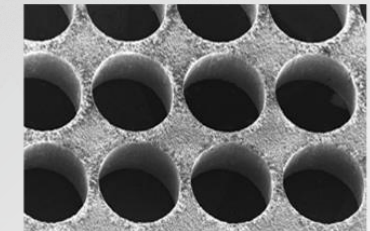
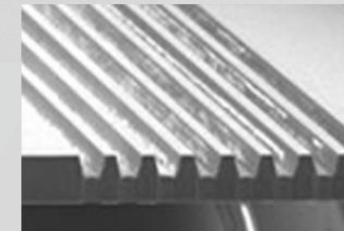
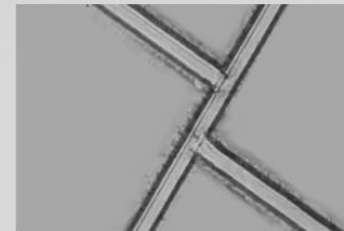
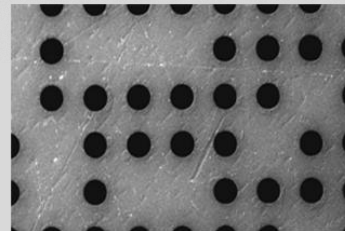
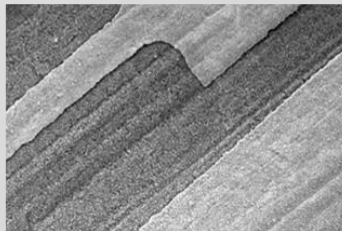
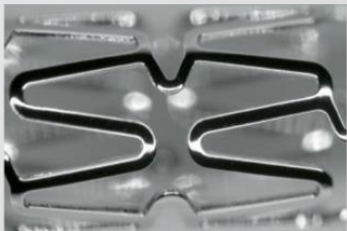

RAILWAYS RELY - ON SLTL

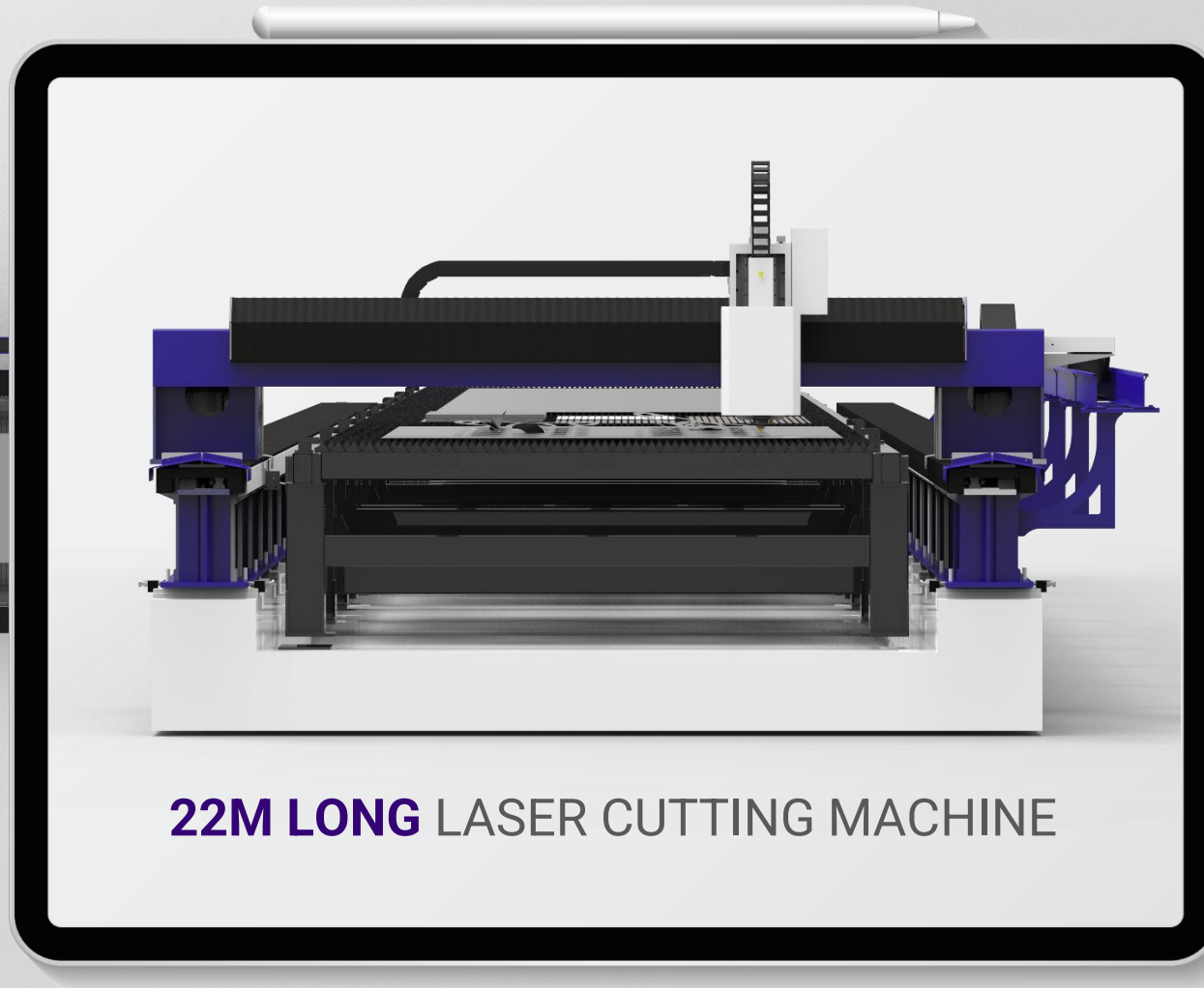

RAILWAYS RELY - ON SLTL

HIGH POWER LASER WELDING MACHINE

Faster. Stronger. Safer.
Train Coaches
WELDING QUALITY IS
ENSURED THROUGH



#LaserExperts | @SLTLGroup



DYE PENETRATE
TEST



BEND
TEST



HARDNESS
TEST

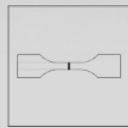

TENSILE
TEST

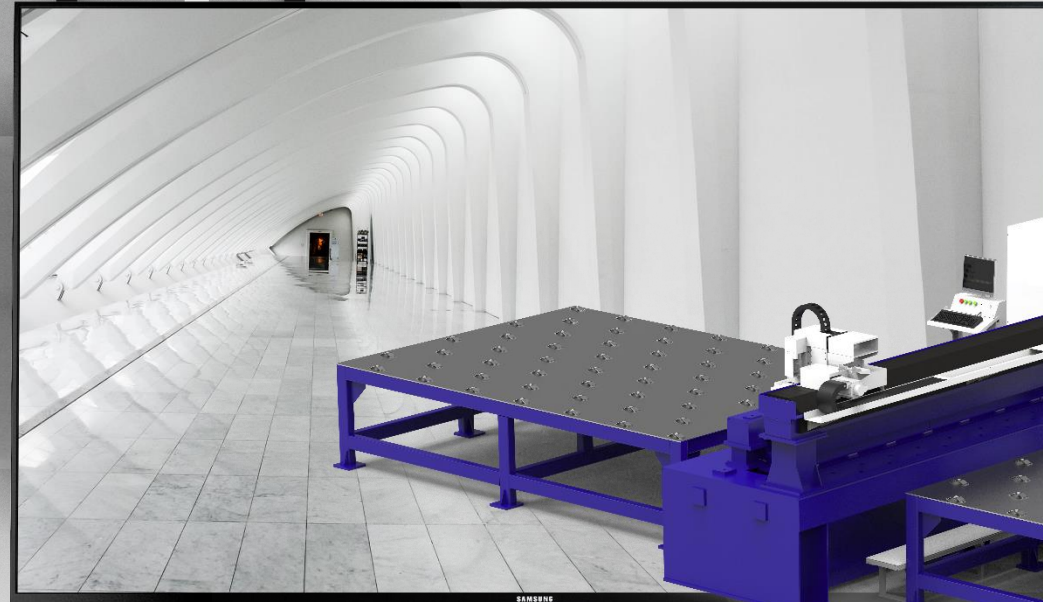

RAILWAYS RELY - ON SLTL



24 METER LONG
LASER CUTTING SYSTEM

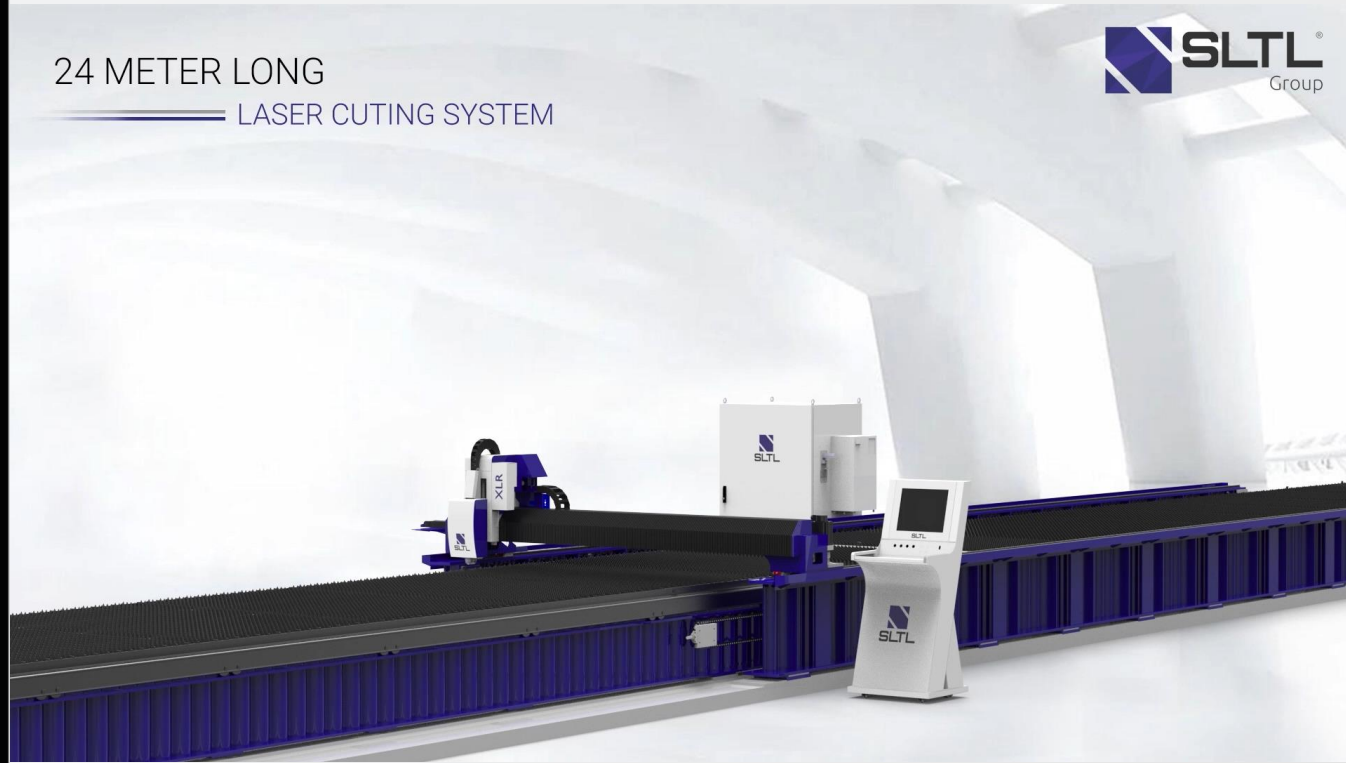

EMBRACING THE VERSATILE FIBER LASER TUBE CUTTING AUTOMATION

TO PROCESS ANGLES, OPEN PROFILES, AND SPECIAL SHAPED PIPES



TECHNOLOGY ERA

Incorporating Internet of Things and Automations to Streamline Production Processes and Increase Operational Productivity

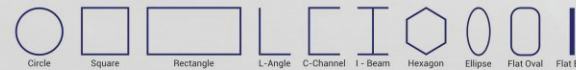
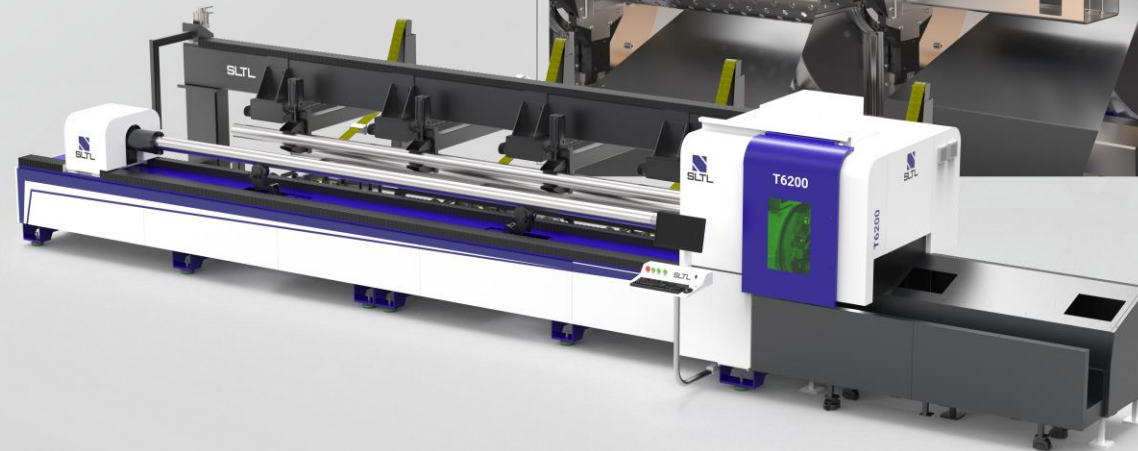
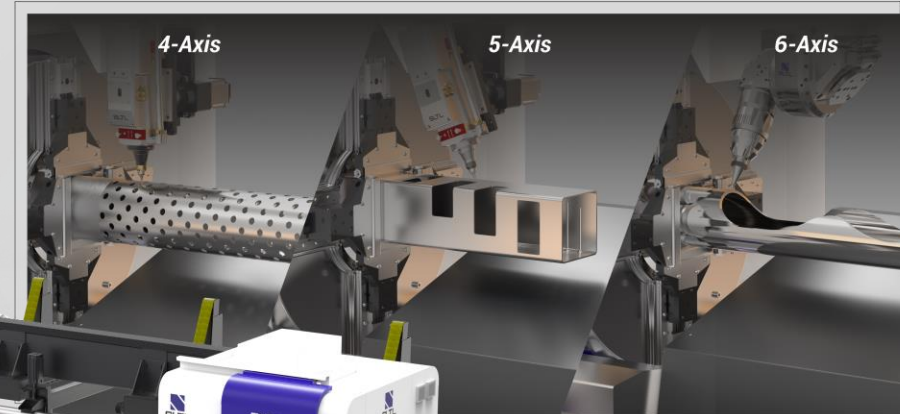

Experts | @SLTLGroup

TUBE CUTTING SYSTEM

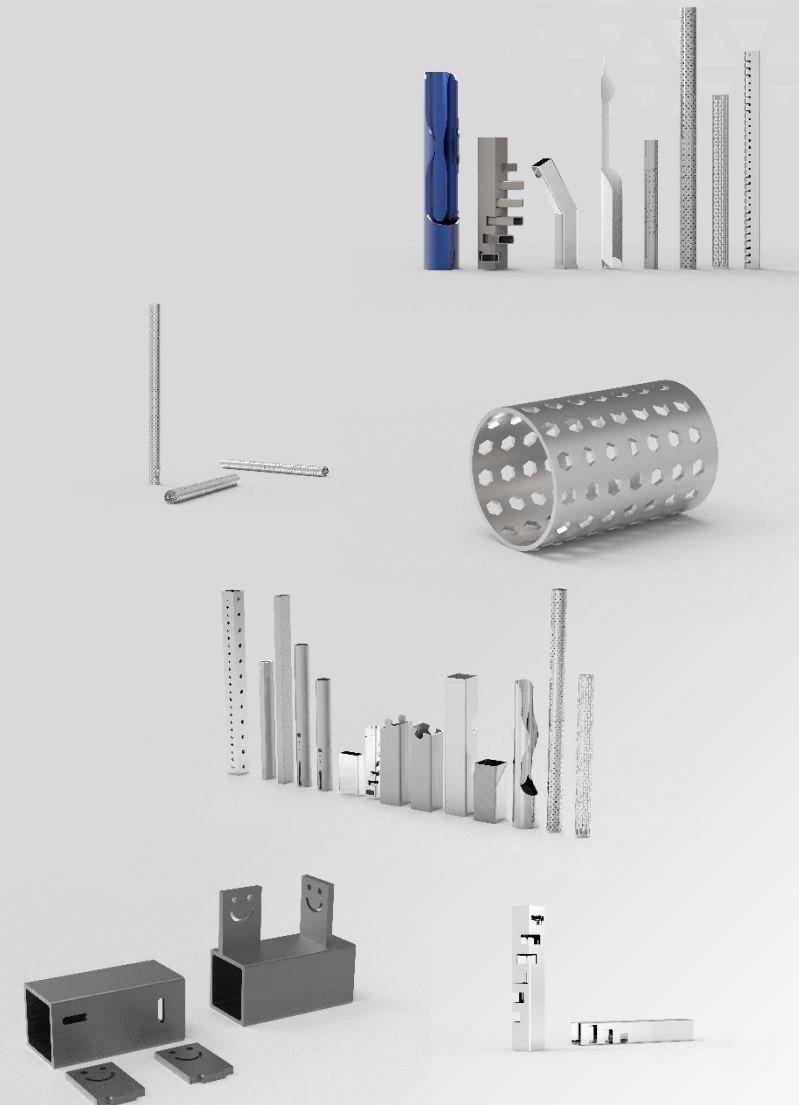

QUANTUM TECHNOLOGY POWERING THE FUTURE AXAYAH URJA GASIFIER



QUANTUM TECHNOLOGY POWERING THE FUTURE
PIONEERING THE GREEN ENERGY FRONTIER
WITH CONCENTRATED RADIANT ENERGY

INDUSTRIAL
WASTE



AGRICULTURAL
WASTE



PHOTOLYSIS PROCESS

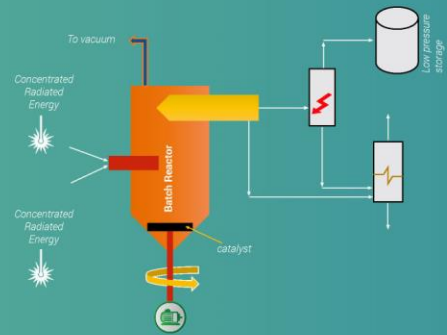

Axayah[®]



BIOGAS



RF SPUTTERING

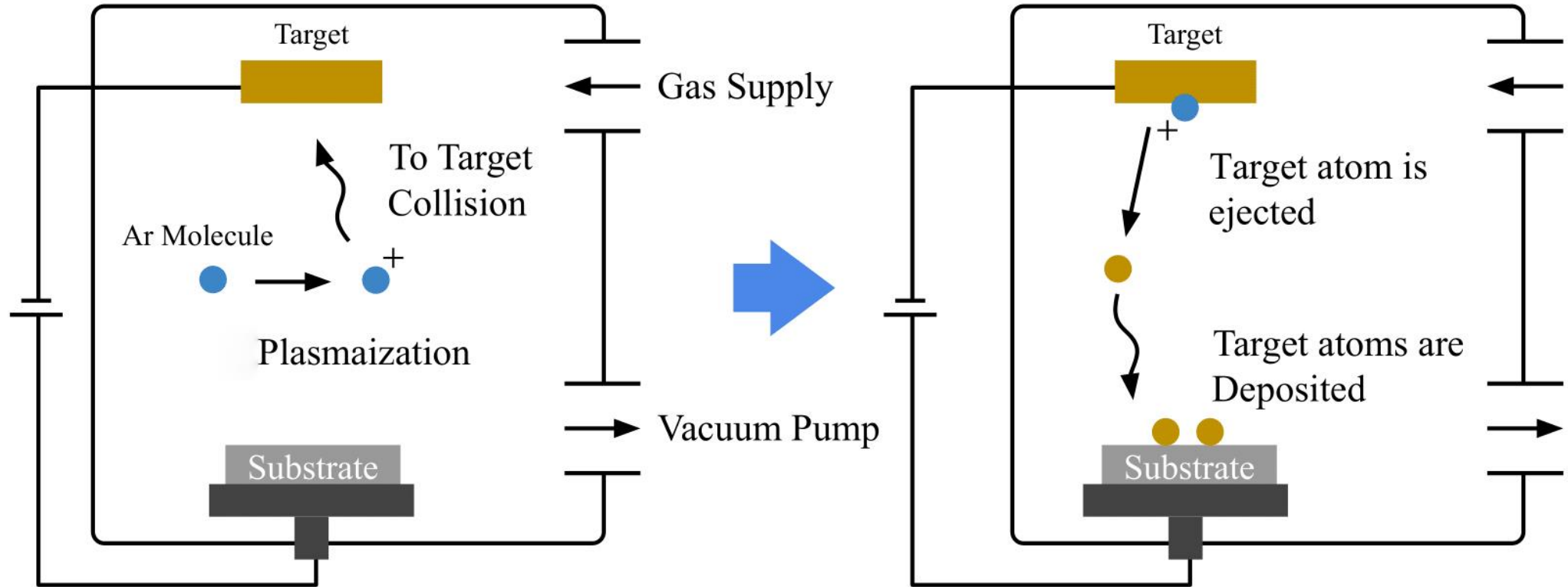

11 AXIS SYSTEM DESIGNED FOR EXTREME PRECISION

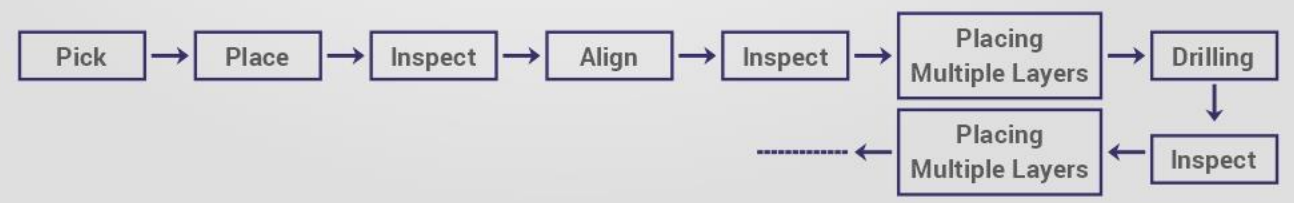
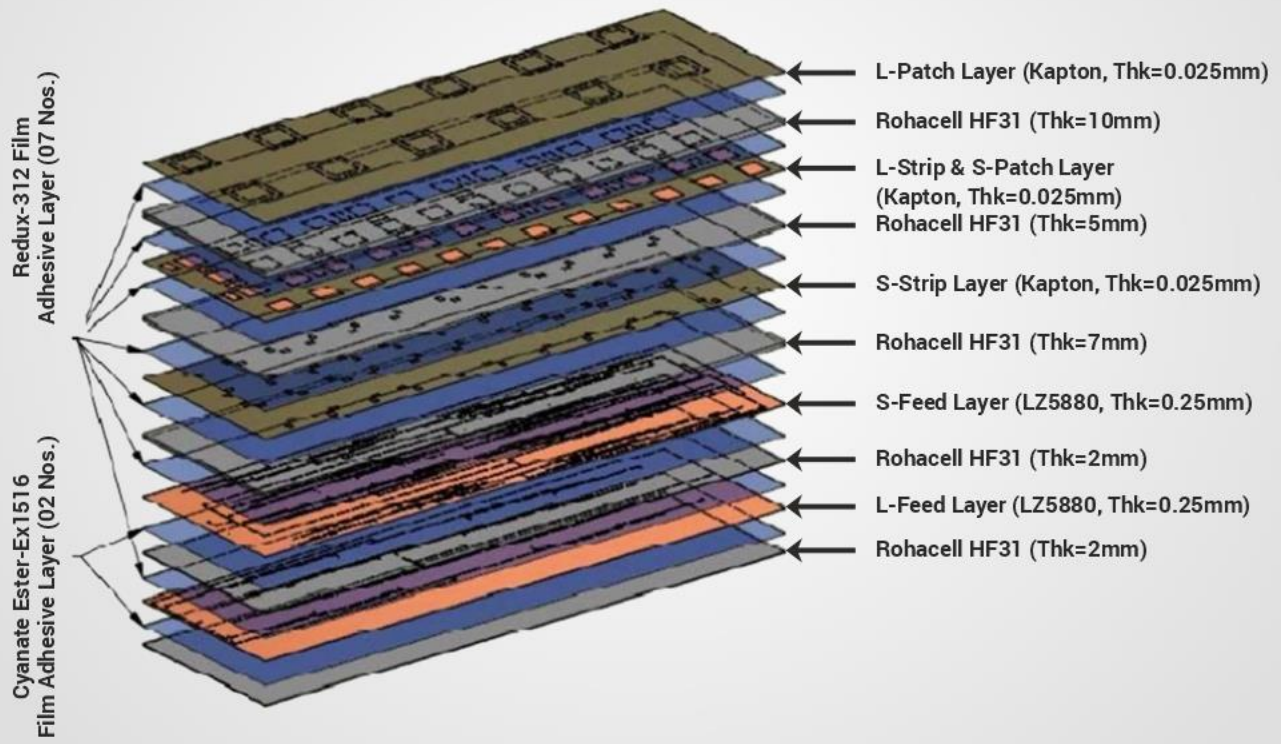

**TYPE OF MULTILAYER PRINTED
ANTENNA ASSEMBLY**

FABRIC CUTTING



DRUM WELDING

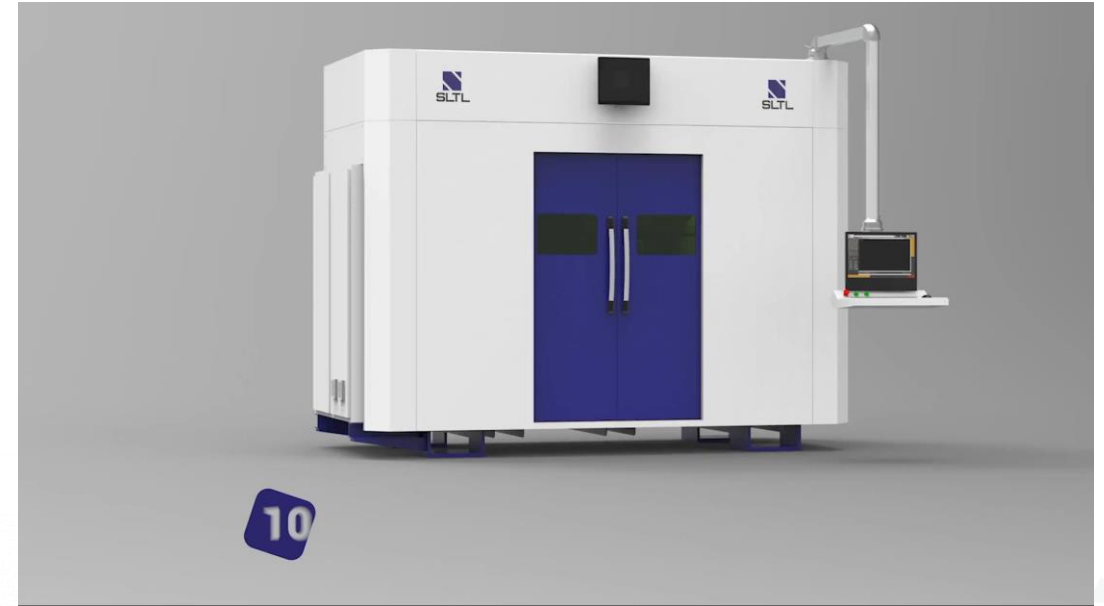
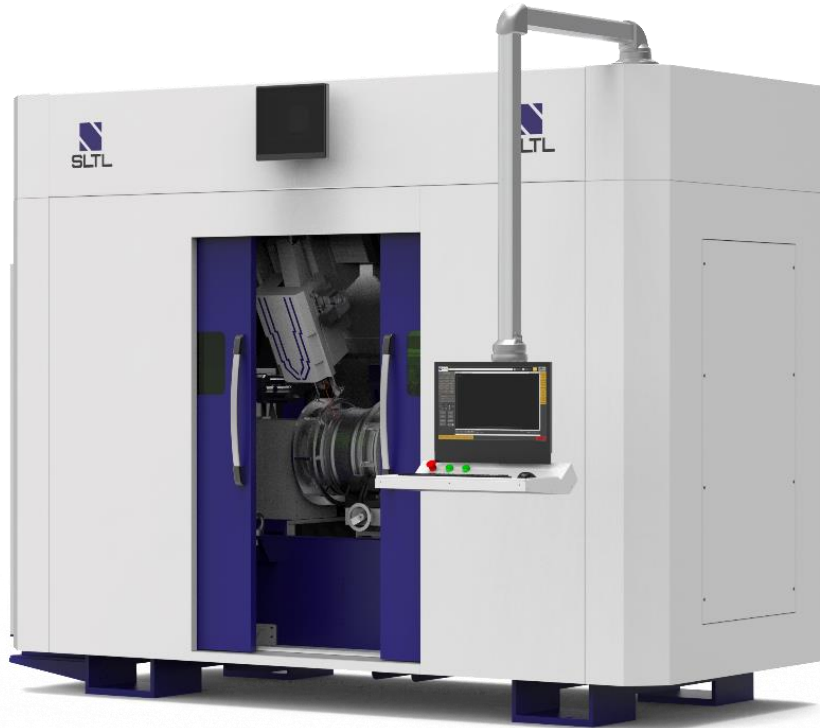

DUAL STATION - RING WELDING

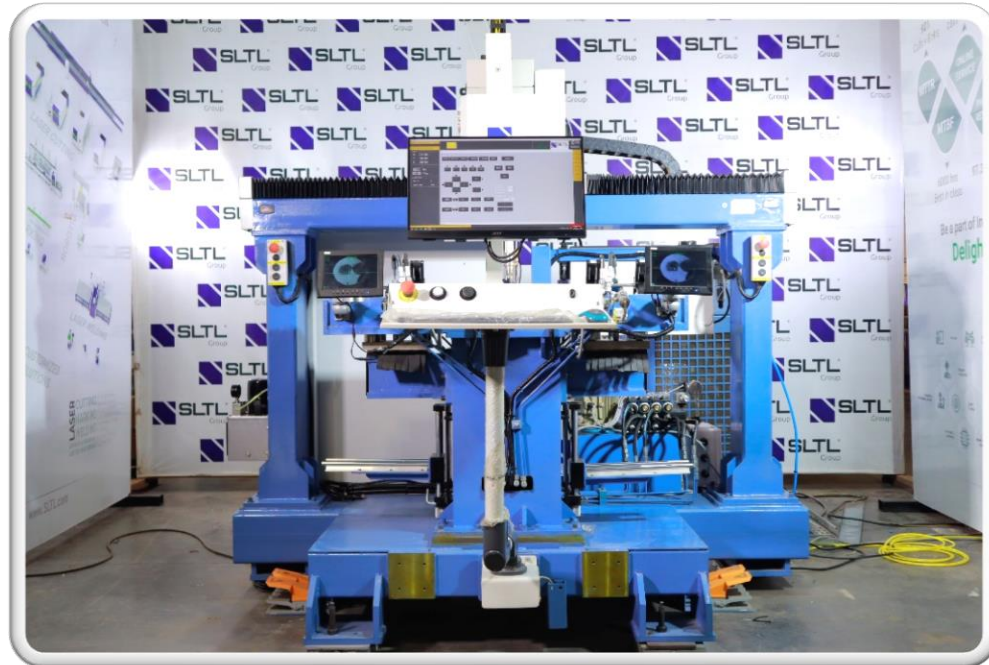

CUTTING AUTOMATION

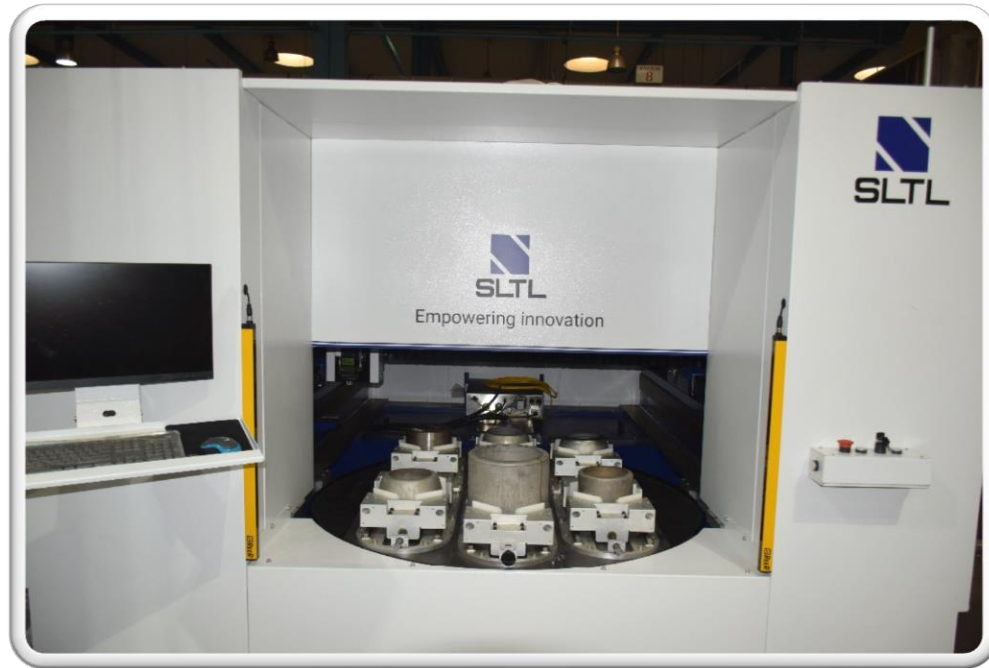

IMPELLER WELDING

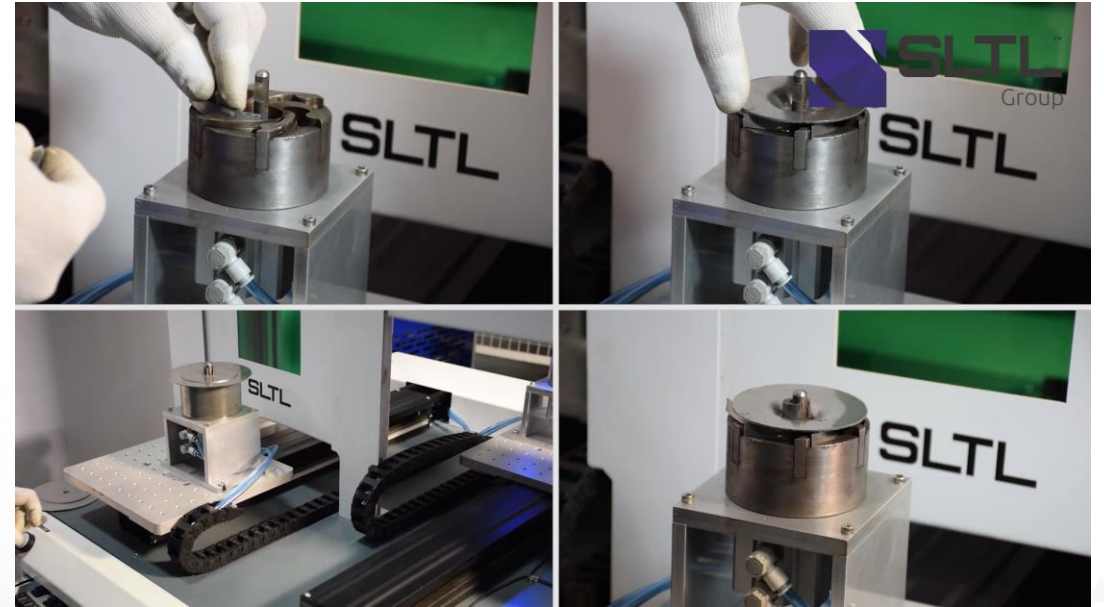
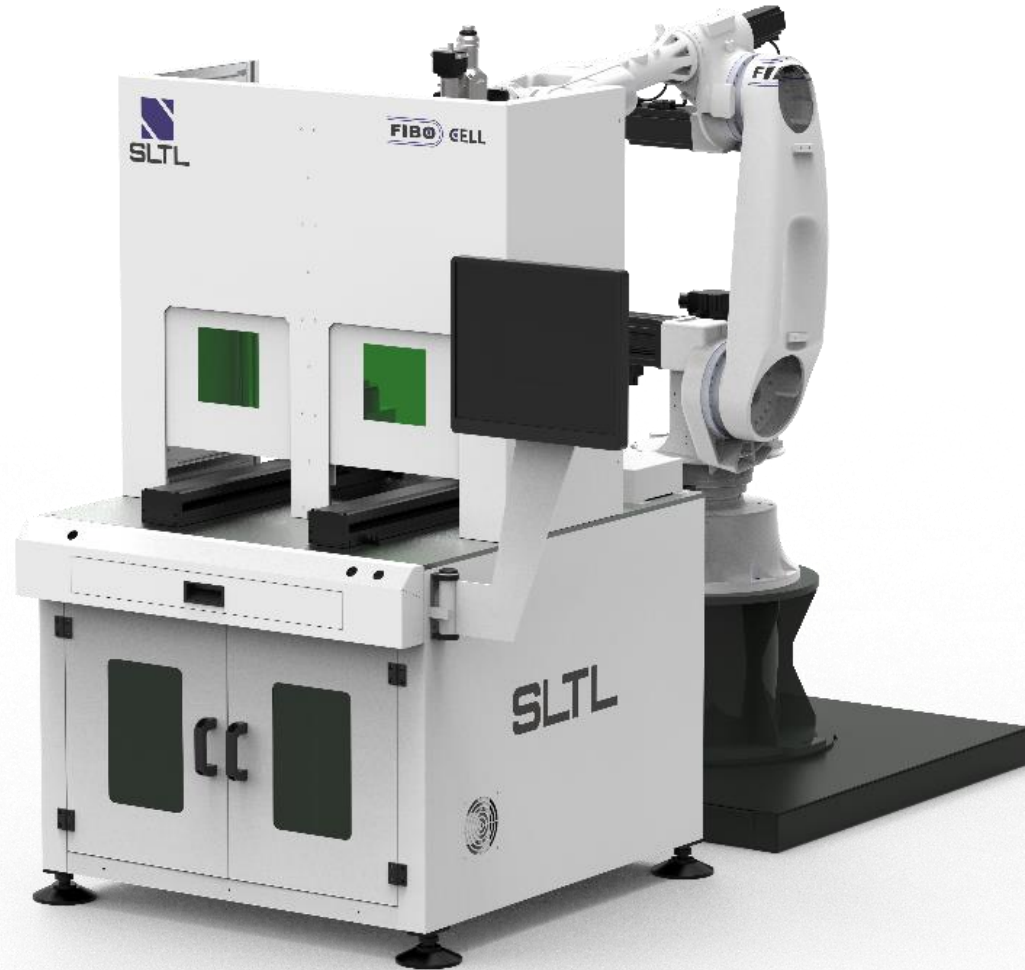

COMPOSITE MATERIAL CUTTING

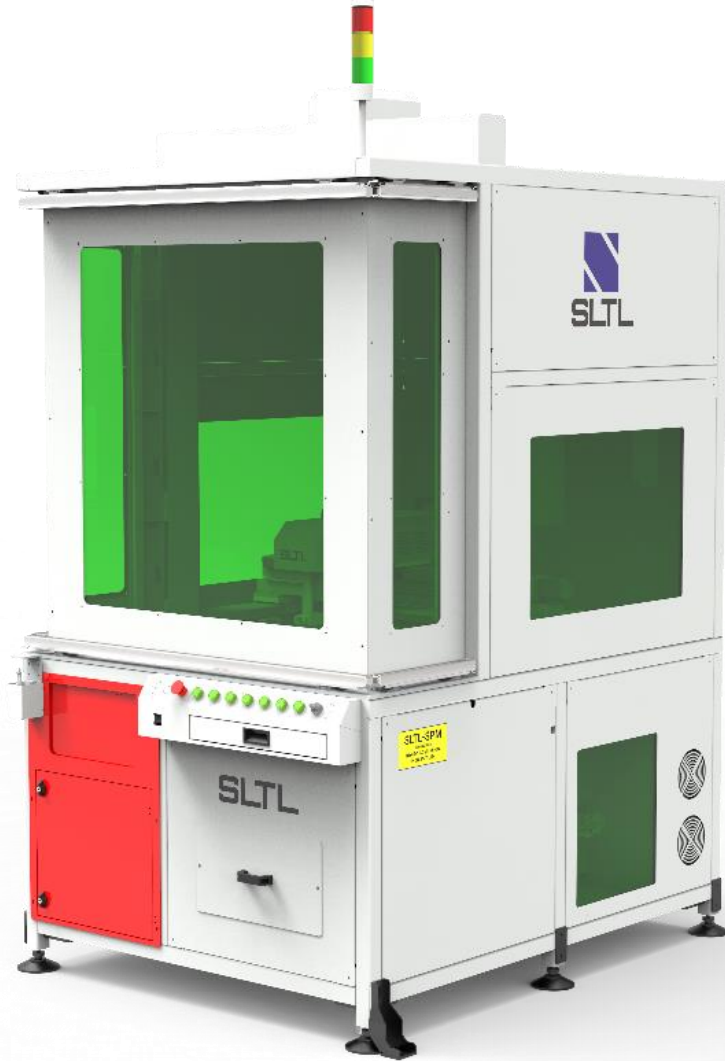

LASER CUTTING OF
COMPOSITE MATERIAL
FOR **AUTOMOTIVE AIRBAGS**







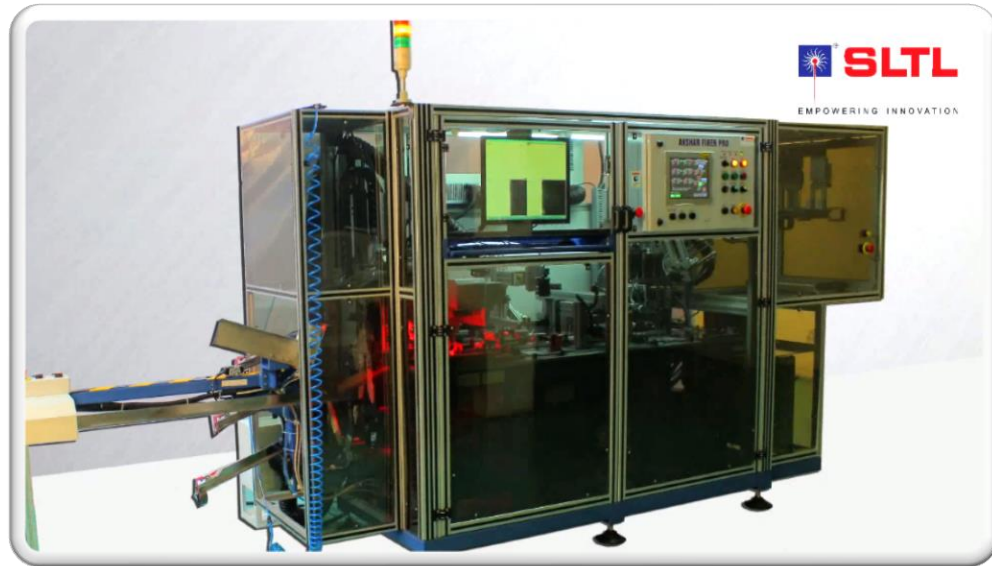















www.SLTL.com

























PISTON RING AUTOMATION



PRESENCE IN 45+ COUNTRIES

-  Algeria
-  Angola
-  Armenia
-  Australia
-  Bahrain
-  Bangladesh
-  Belgium
-  Botswana
-  Brazil
-  Canada
-  China
-  Czech Republic
-  DRC
-  France
-  Germany
-  Hong Kong
-  India
-  Iran
-  Israel
-  Italy
-  Kenya
-  Kuwait
-  Mauritius



-  Mexico
-  Namibia
-  Nepal
-  New Zealand
-  Poland
-  Qatar
-  Russia
-  Saudi Arabia
-  Scotland
-  Singapore
-  South Africa
-  South Korea
-  Sri Lanka
-  Switzerland
-  Thailand
-  Turkey
-  UAE
-  Ukraine
-  United Kingdom
-  USA
-  Vietnam
-  Zimbabwe



SEEKING GLOBAL PARTNERSHIPS FOR TECHNOLOGY COLLABORATION AND PRODUCT INNOVATION

Be a part of India's Biggest Community of Delighted Customers

Fiber laser cutting machine
**WORLD'S
FIRST**

Successfully installed
More Than
25000
Systems



CE An ISO 9001:2015 Certified Company

Sahajanand Laser Technology Ltd. (SLTL Group)

E-30, Electronic Estate, G.I.D.C., Sector - 26,
Gandhinagar - 382 028, Gujarat, India.

Tel : +91-79-6170-1616 | Fax : +91-79-2328-7470

+91-99-2503-6495 | mkt@SLTL.com | www.SLTL.com



Scan For More
Information