

# Optical Communication Systems

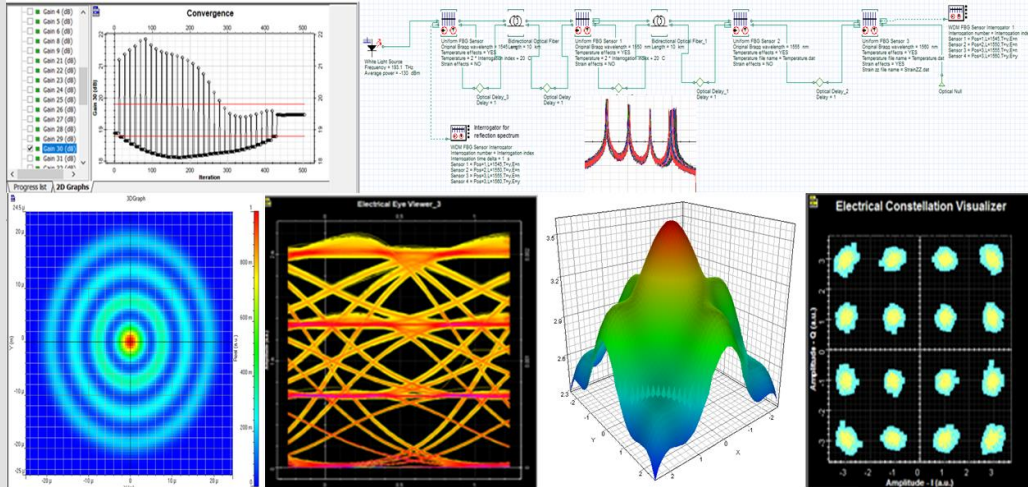

# Integrated Circuits



## Optical CML Plugin for SPICE & EDA Tools

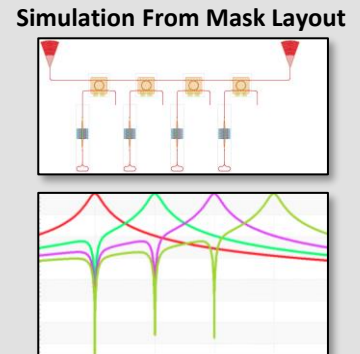
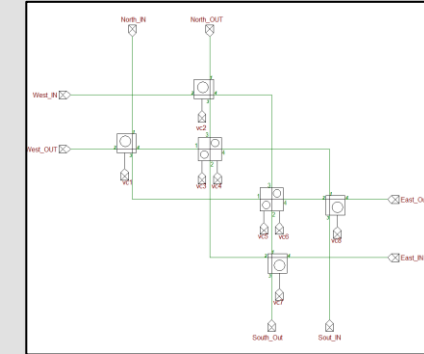
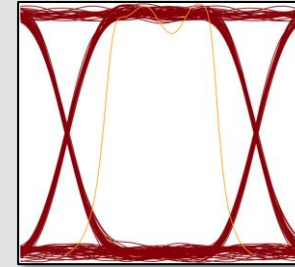
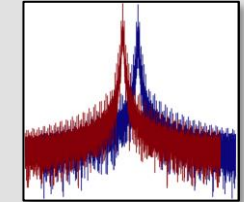
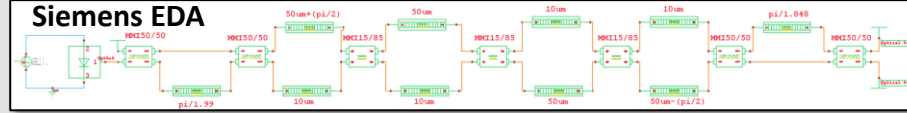

OptiSystem has over 580 components and over 1000 Example

# Test and Measurement



## End to End – Transceiver Test System Setup

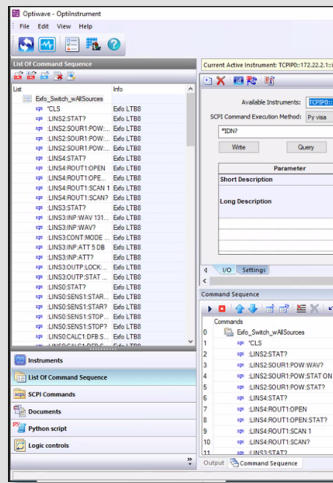
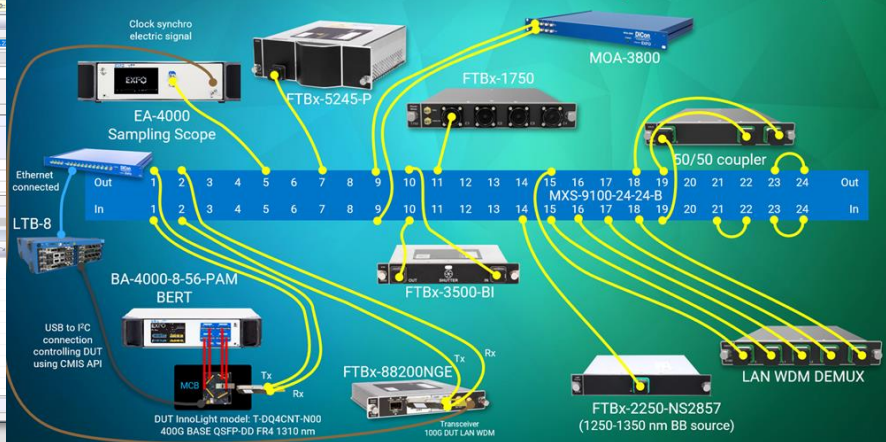

OptiInstrument communicates with instruments and automate their operation using remote control scripts

# Photonic Devices

- OptiFDTD
- OptiBPM
- OptiGrating
- OptiFiber
- OptiMode

